

Fire alarm systems

Protective cover for detector, 6360



- Protection against physical damage
 - Protection against theft
-

Protection

The protective cover for detector is made of white painted steel. It will protect the detector against physical damage and theft.

The cover is made of two parts, a mounting plate and a cage. An M4 screw is used to lock the two parts together.

Product applications

Used together with any of the Panasonic heat or smoke detectors plugged in a base.

Type number

6360

Protective cover for detector.

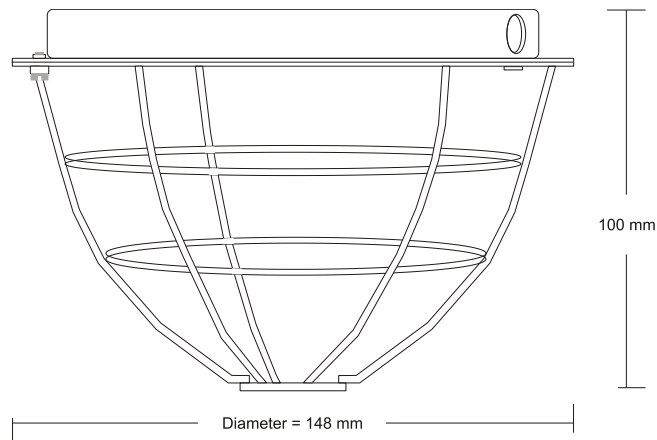

The locking screw is an **M4** (cheesehead, slotted). Could be changed, if required, to a more suitable type of head (Torx, Hexagon, etc.). Length 10 mm.

Technical data

Size Ø x H (mm)	150 x 100
Weight (kg)	0.32
Colour	White

All technical features and data are subject to changes without notice, resulting from continuous development and improvement.

Product Leaflet	Date of issue	Revision / Date of revision
MEW00120	2001-10-19	3 / 2011-03-14